

# THEREC CORPORATION LTD.

## Silo Operating Equipment

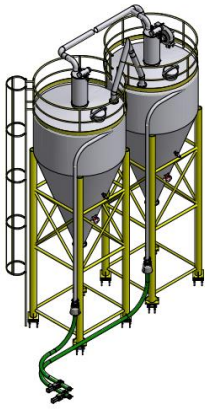

30 m<sup>3</sup> Stainless Steel Wheat Flour Storage Silo system

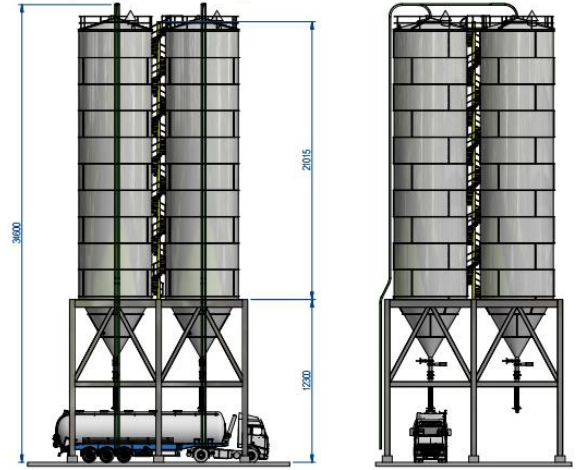
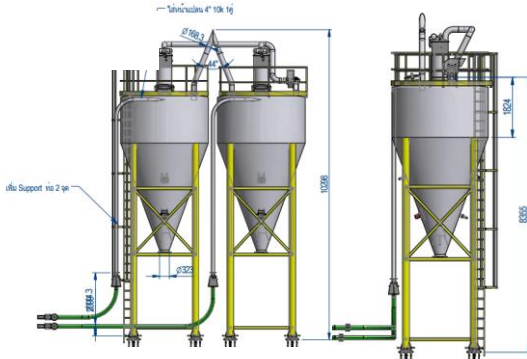

Gravity Feed Bulk Truck Loading System



100 m<sup>3</sup> Stainless Steel PVC Resin Storage Silo system

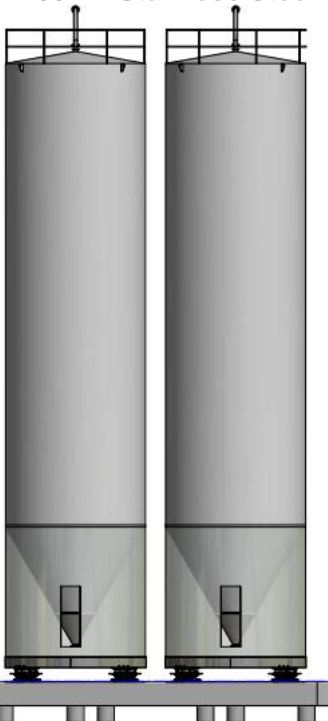

200 m<sup>3</sup> Aluminium, Plastic Pellet Storage Silo system

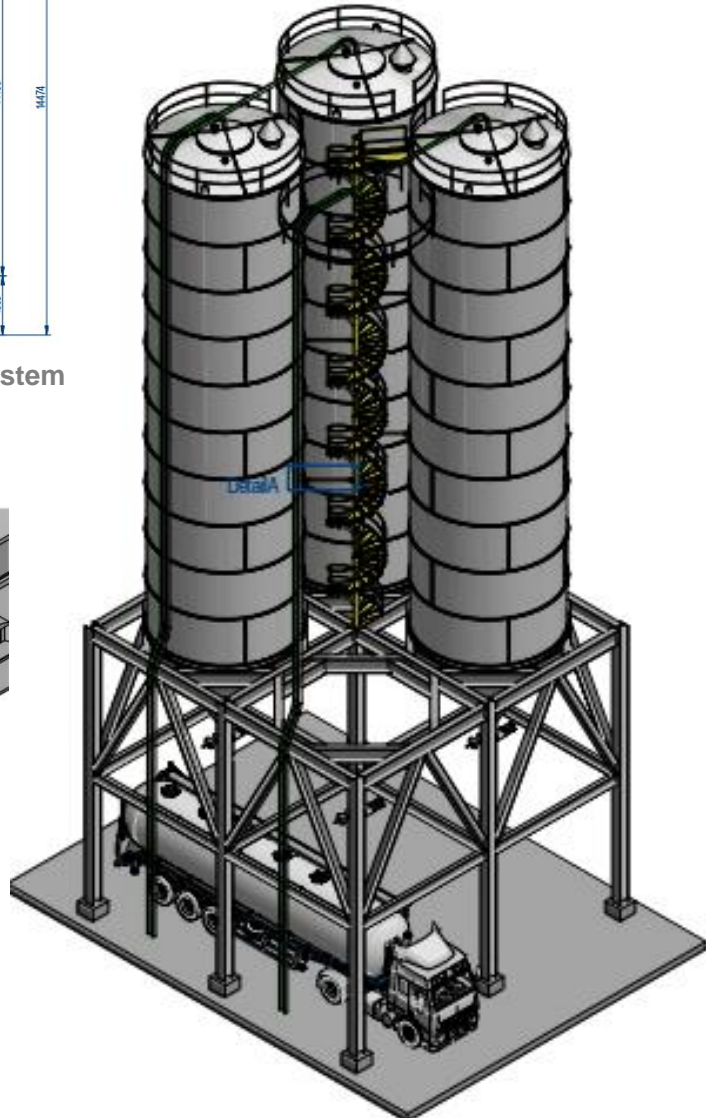
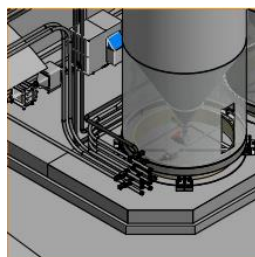
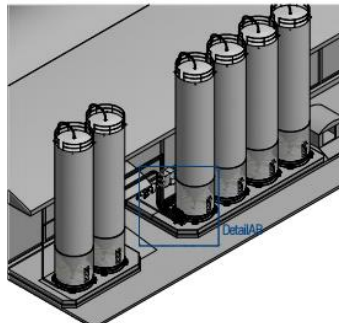

500 m<sup>3</sup> Aluminium, Knock Down Plastic Pellet Storage Silo system

# Bulk Material Silo Loading & Unloading Equipment



Three Major Bulk Material Packages are coming in Bulk Truck, Bulk Container & Jumbo Bag

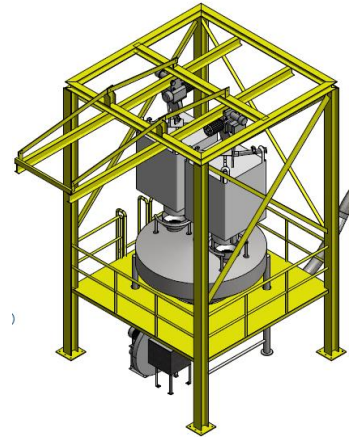
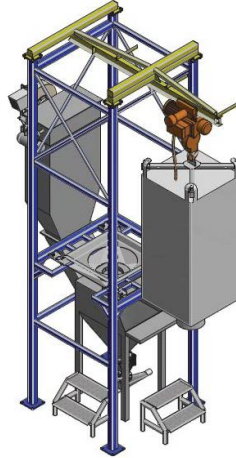
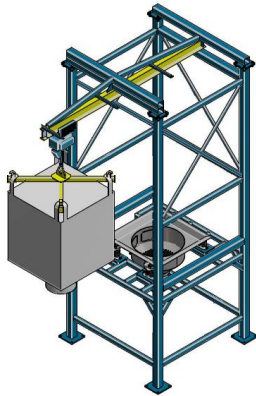
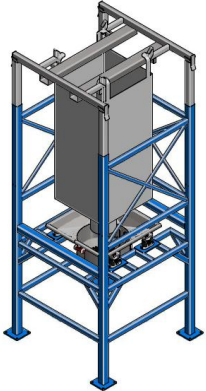

Dust Free, Easy Operating Bulk Material Bag Unloading Station with Capacity Up to 35 Bags/Hour, Max.

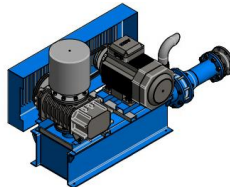
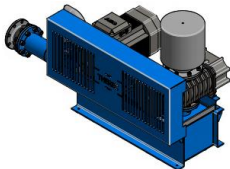

Oil Free, High-Pressure Roots Blower with operating pressure up to 1,200 mBar

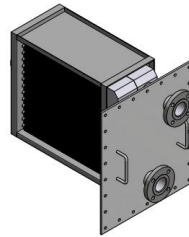
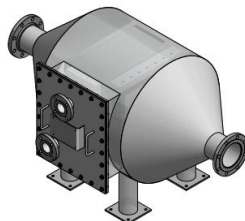
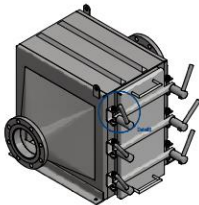
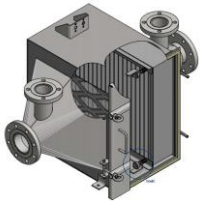

Super Fine Particle, Outlet Air Filter

Fin-Tube, Outlet Air Cooler, Air to Water



High Pressure Air Lock Rotary Valve , Powder Type and Granular Type  
 Sizes up to 20.0 inches with Conveying Capacity up to 50 tons/hour

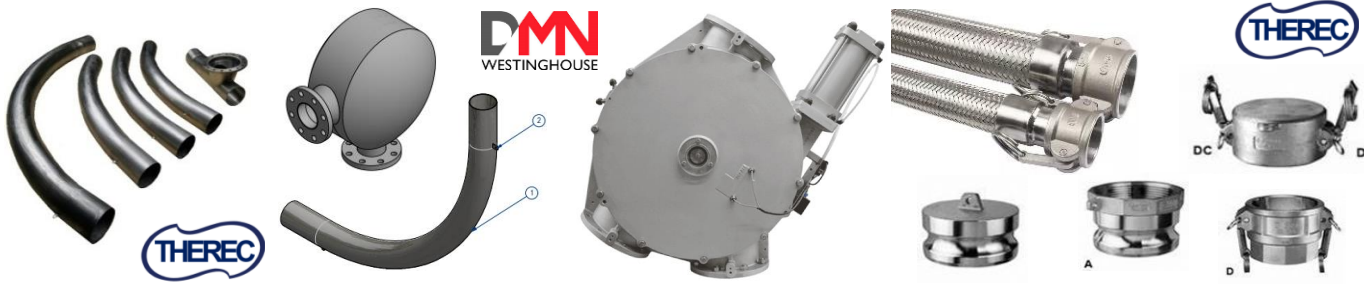

Long Radius Bend & Rino Bends

Divertor Valve

Flexible House & Quick Coupling

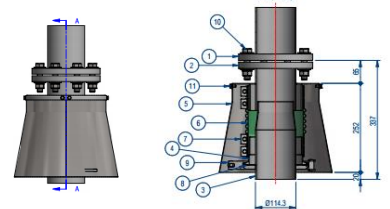
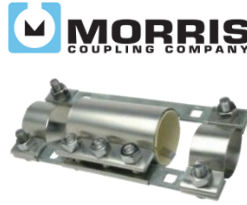

Compression Coupling & Sight Glass

Feeding Pipe Flexible Connecting

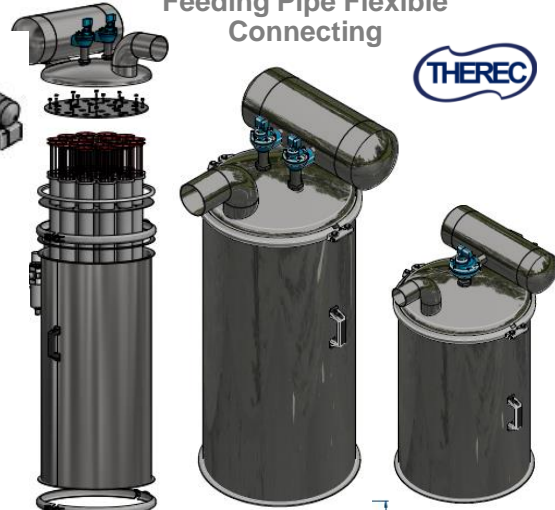
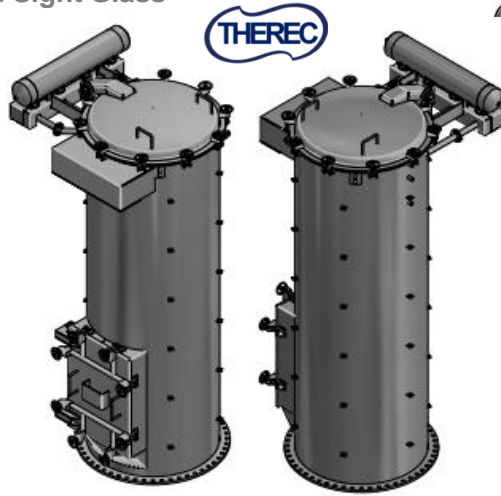

General Case Silo Vent Bag filter

Special Design Silo Vent Bag filter

Food Grade Easy Clean Silo Vent Bag filter



Silo Dust Explosion Protection panel & Frame Arrestor

VIGILEX®

Air Knocker

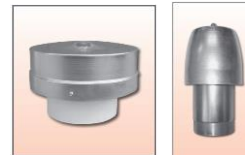

Silo & Tank Safety Valve



Loading Bellow For Tank Car

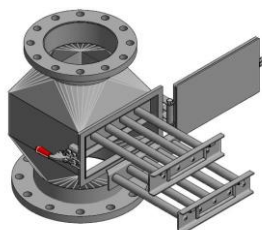

Magnetic Separator

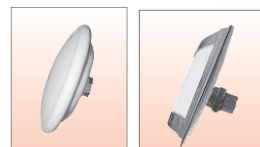

Powder Silo Air Diffuser



Silo Slide Gate Valve



# Bulk Material Silo Loading & Unloading Equipment



Tank Car with Feeding Blower



Feeding Hose



Feeding Pipe, Bends & Diverter Valve



Silo & Tank Safety Valve



Special Design Silo Vent Bag filter



Food Grade & Easy Clean Silo Vent Bag filter

Silo Dust Explosion Protection panel



Silo Breathing Vent filter & Silo Top Level Sensor

Magnetic Separator with Gravity Feed Diverter Valve



Slide Gate Valve, Flexible Connecting & Rotary Valve



Multi Port Drop Out Box



Silo Loading Bello with Over Filled Level Sensor



# Bulk Material Silo Monitoring & Control Equipment

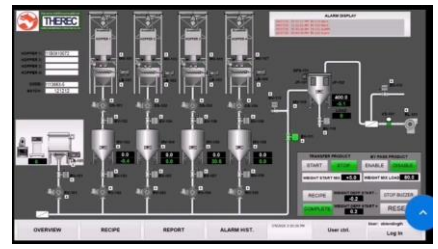
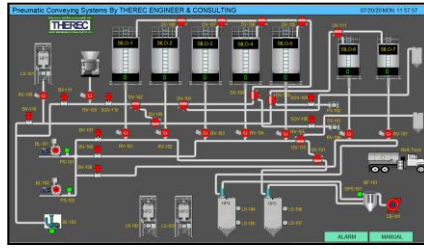
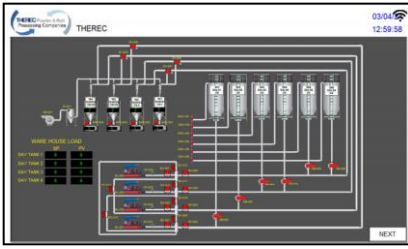

Raw Bulk & Powder Material Handling System / Control & Monitoring Computer Screen Page



Vibrating Rod & Fork Silo Level sensor



Jet Pulse Cleaning Valve and Control Circuit



Humidity Transmitter



Mass Flow Transmitter



Flow Switch



Smart Digital & Analog Load Cell Indicator Display



Bending Beam Anti Vibration Small Loadcell



Shear Beam Anti Vibration Medium Size Loadcell



Material Sampling Valve



Silo Low profile mounting Shear Beam & Pan\_Cake\_load cell



Silo mount , Atex & IECEx Certification



Easy Detachable Load Cell Assembly

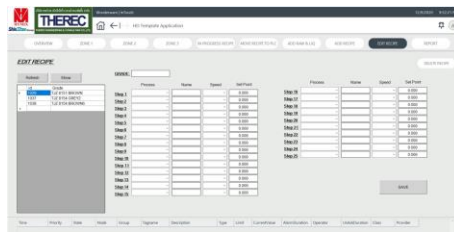

Raw Bulk & Powder Material Handling System / Several Reports, Computer Screen Page

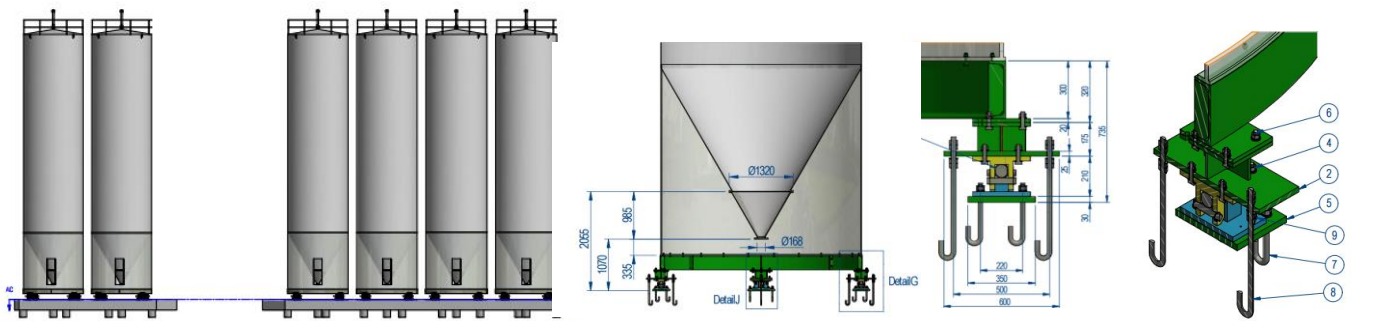

200 m<sup>3</sup> SUS304, PP Storage Silos with Shear Beam Silo Load Cell Sets

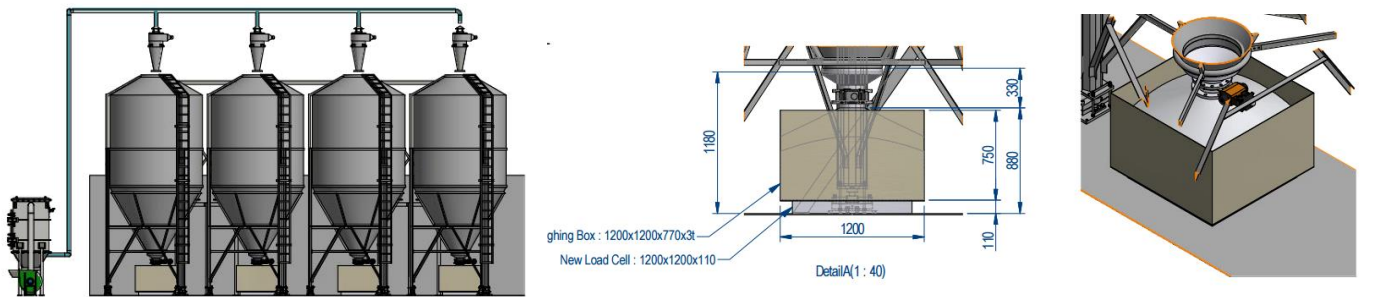

20 m<sup>3</sup> Plastic, PP Intermediate Silos with Shear Beam Silo Load Cell Sets and Weighing Buffer Hopper



100 m<sup>3</sup> SUS304, PP, PE, PS & PET Storage Silos with Low Profile Pan Cake Load Cell Sets

# Total Package Solution for Bulk Material Silo Operation

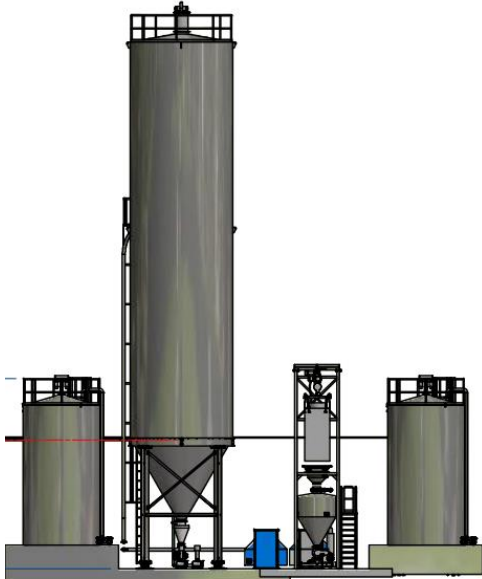

100 m<sup>3</sup> & 200 m<sup>3</sup> SUS304, PVC Storage Silos with Loading System from Bulk Truck (Tank Car) & Big Bag

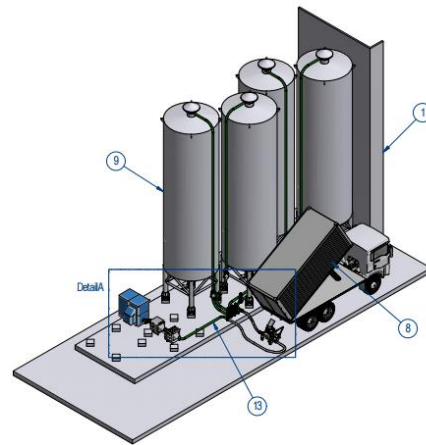
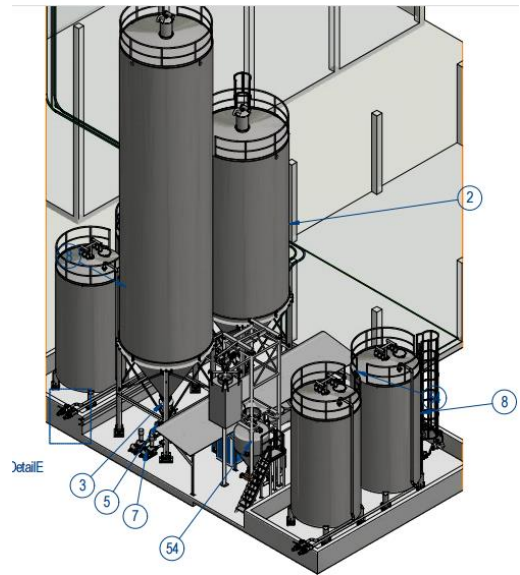

100 m<sup>3</sup> SUS304, PP,PE,PS & PET Storage Silos with Loading System from Container Truck

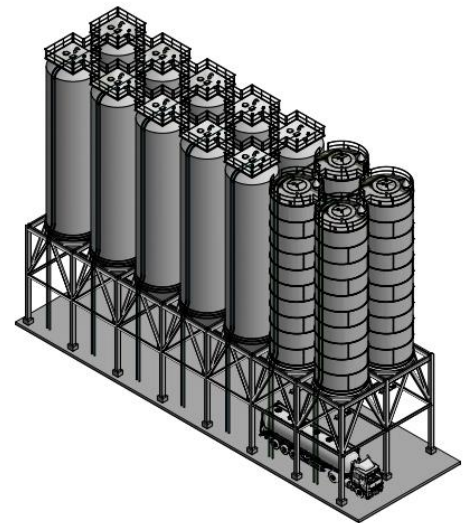
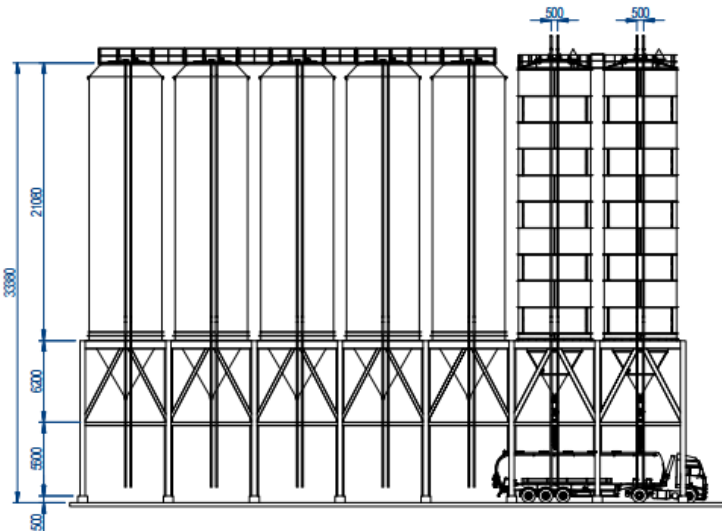

500 m<sup>3</sup> SUS304, PP,PE&PS Storage Silos with Loading System from Bulk Truck (Tank Car) and Unloading to the Bulk Truck, Container Truck, Big Bag or Loose Bag again for distribution

**Therec Corporation Ltd.** [www.thereccorp.com](http://www.thereccorp.com)

Tel ☎ (662) 893 9003-4 Fax : (662) 893 9005

88 Soi Karnjanapisek 4/2 Karnjanapisek Rd. Bangbon Bangkok 10150

General product TRC01 / 2025

